



**SOLUCIONES
SOSTENIBLES**



**SOLUCIONES
EMPAQUES
INTELIGENTES**





RESPONSABILIDAD

Nuestra responsabilidad con el medio ambiente va más allá de nuestra empresa.

En Globalpak contamos con programas de reciclaje y reutilización de materias primas, a través de los cuales nuestros productos son respetuosos con el medio ambiente y nos convierte en una empresa con la responsabilidad de mantener el planeta en buenas condiciones y por lo tanto la salud de nuestros consumidores...

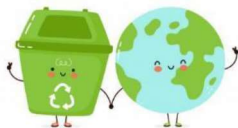

ECO friendly



BIENVENIDOS A GLOBALPAK

Globalpak es una empresa familiar ubicada en la Ciudad de Guatemala que se dedica no sólo a la industria del plástico, sino a satisfacer a los clientes. Globalpak ha estado 27 años en la industria del plástico, pero sus propietarios llevan más de 65 años en el mismo.

Globalpak produce una amplia variedad de productos desechables y envases de plástico. En la presentación adjunta se pueden ver todos los productos que Globalpak puede ofrecer.

Globalpak es una empresa que está en constante crecimiento debido a la calidad de sus materias primas y precios competitivos. Trabajamos con plásticos como PP (Polipropileno), PET (Tereftalato de polietileno), siendo productos 100% reciclables + Fécula de Maíz, haciendo nuestros productos **BIOCOMPOSTABLES**.

GLOBALPAK + PLANETA + MEDIO AMBIENTE

En Globalpak practicamos la BIO-Economía circular, un sistema económico destinado a eliminar el despilfarro y el uso continuo de los recursos.... Este enfoque regenerativo contrasta con la economía lineal tradicional, que tiene un modelo de producción "tomar, hacer, eliminar". Es por eso que en Globalpak todos nuestros productos están hechos con 100% R-PET (PET reciclado).



GLOBALPAK

CUIDA NUESTRO PLANETA
COMO **CUIDAMOS** DE SUS PRODUCTOS...

Nuestra responsabilidad con el medio ambiente va más allá de nuestra empresa.

En Globalpak ayudamos a limpiar el planeta recogiendo botellas de PET y las reciclamos y procesándola en nuestro sistema de termo formado para así lograr un empaque seguro para alimentos 100% reciclados con una transparencia y sobre todo precios razonables.

Nos preocupamos por nuestro planeta y estamos en constante crecimiento para mejorar en nuestros materiales siempre ayudando al PLANETA TIERRA.



NUESTROS MATERIALES

R-PET: Significa tereftalato de polietileno reciclado, o PET reciclado.

El PET (tereftalato de polietileno) es un polímero utilizado para fabricar contenedores o cualquier empaque reduciendo tiempos, duraderos y 100%reciclables.

CPLA: Copolímero alifático polilactido. CPLA biodegradable es una mezcla de poliésteres lactidas y alifáticos. Puede ser un plástico duro, pero tiene transparencia como un material PET siendo un plástico con bases primarias del maíz.

FECULA DE MAIZ: Biocompostables están hechos de almidón de maíz.

El almidón se convierte en un polímero, el ingrediente principal en materiales que tienen una sensación de plástico. Los plásticos pueden ser claros u opacos, blandos o duros. Un tipo de ácido llamado ácido poli láctico (PLA) se hace a partir del almidón de maíz.

NUESTROS MATERIALES SON CERTIFICADOS:





eco

2020 CATALOGO





NEW

CATALOGO: Protectores Faciales



Protector Facial Antivirus-SPORT Antivirus Face Mask-SPORT



Dimensiones / Dimensions:

Largo/ Length : 230 mm +/- 3 mm

Ancho/ Width: 300 mm +/- 3 mm

Alto/ Height: 60 mm +/- 3 mm

Espesor / Thickness 380 micras +/- 20 micras



Unidad de Empaque / Packaging Unit :

Caja de 25 Unidades.

Box of 25 Units.

Especificaciones / Specifications:

- Fabricado en R-PET / Made in R-PET
- Temp Max 50°C / Max Temp 50°C
- Resistente / Resistant
- Transparencia / Clear
- Made in GUATEMALA



PROTECTOR FACIAL
Seguridad & Protección



Modo de Limpieza y Desinfección // Cleaning and disinfection mode

- Lavarlo con agua y jabón // Wash it with soap and water
- Secarlo con toallas desechables de papel // Dry with disposable towels
- Aplicar solución clorosa / agua // Apply Chlorine / water solution (10 Partes Agua x 1 Parte Cloro) (10 parts water x 1 part chlorine)





eco

CATALOGO: BANDEJAS ABISAGRADA



ID#: 8 DC



Dimensiones / Dimensions:

Largo/ Length : 9.5 cm / 3.74" Inch
Ancho/ Width: 9.5 cm / 3.74" Inch
Alto/ High: 8.5 cm / 3.34" Inch

Unida de Empaque / Packaging Unit :

Caja de 480 Unidades.
Box of 480 Units.
Caja No. /Box No.: 6
Cod. #: **6605001**

Especificaciones/ Specifications:

- Fabricado en R-PET / Made in R-PET
- Temp Max 50°C / Max Temp 50°C
- Resistente / Resistant



ID#: 16 DRO



Dimensiones / Dimensions:

Largo/ Length : 10.6 cm / 4.17" Inch
Ancho/ Width: 10.0 cm / 3.94" Inch
Alto/ High: 5.7 cm / 2.24" Inch

Unida de Empaque / Packaging Unit :

Caja de 400 Unidades.
Box of 400 Units.
Caja No. /Box No.: 6
Cod. #: **6605011**

Especificaciones/ Specifications:

- Fabricado en R- PET / Made in R-PET
- Temp Max 50°C / Max Temp 50°C
- Resistente / Resistant



ID#: 30 DRO



Dimensiones / Dimensions:

Largo/ Length : 11.5 cm / 4.53" Inch

Ancho/ Width: 9.8 cm / 3.86" Inch

Alto/ Hight: 7.3 cm / 2.87" Inch

Unida de Empaque / Packaging Unit :

Caja de 400 Unidades.

Box of 400 Units.

Caja No. /Box No.: 6

Cod. #: **6605021**

Especificaciones/ Specifications:

- Fabricado en R-PET / Made in R-PET
- Temp Max 50°C / Max Temp 50°C
- Resistente / Resistant



ID#:31 DRO

**Dimensiones / Dimensions:**

Largo/ Length : 16.0 cm / 6.30" Inch

Ancho/ Width: 13.6 cm / 5.35" Inch

Alto/ Hight: 5.5 cm / 2.17" Inch

Unida de Empaque / Packaging Unit :

Caja de 450 Unidades.

Box of 450 Units.

Caja No. /Box No.: 1

Cod. #: **6605024**

Especificaciones/ Specifications:

- Fabricado en R-PET / Made in R-PET
- Temp Max 50°C / Max Temp 50°C
- Resistente / Resistant



ID#: 40 DR



Dimensiones / Dimensions:

Largo/ Length : 15.5 cm / 6.10" Inch

Ancho/ Width: 15.5 cm / 6.10" Inch

Alto/ Hight: 8.5 cm / 3.35" Inch

Unida de Empaque / Packaging Unit :

Caja de 150 Unidades.

Box of 150 Units.

Caja No. /Box No.: 3

Cod. #: **6605043**

Especificaciones/ Specifications:

- Fabricado en R-PET / Made in R-PET
- Temp Max 50°C / Max Temp 50°C
- Resistente / Resistant



ID#:40 DRO



Dimensiones / Dimensions:

Largo/ Length : 16.1 cm / 6.34" Inch

Ancho/ Width: 13.5 cm / 5.31" Inch

Alto/ Hight: 5.0 cm / 1.97" Inch

Unida de Empaque / Packaging Unit :

Caja de 200 Unidades.

Box of 200 Units.

Caja No. /Box No.: 6

Cod. #: **6605040**

Especificaciones/ Specifications:

- Fabricado en R-PET / Made in R-PET
- Temp Max 50°C / Max Temp 50°C
- Resistente / Resistant



ID#: 200 BC

**Dimensiones / Dimensions:**

Largo/ Length : 12.3 cm / 4.84" Inch

Ancho/ Width: 12.8 cm / 5.04" Inch

Alto/ Hight: 6.5 cm / 2.56" Inch

Unida de Empaque / Packaging Unit :

Caja de 500 Unidades.

Box of 500 Units.

Caja No. /Box No.: 6

Cod. #: **6605073**

Especificaciones/ Specifications:

- Fabricado en R-PET / Made in R-PET
- Temp Max 50°C / Max Temp 50°C
- Resistente / Resistant



ID#: 225 BC



Dimensiones / Dimensions:

Largo/ Length : 11.5 cm / 4.53" Inch

Ancho/ Width: 11.5 cm / 4.53" Inch

Alto/ Hight: 6.0 cm / 2.36" Inch

Unida de Empaque / Packaging Unit :

Caja de 500 Unidades.

Box of 500 Units.

Caja No. /Box No.: 6

Cod. #: **6605014**

Especificaciones/ Specifications:

- Fabricado en R-PET / Made in R-PET
- Temp Max 50°C / Max Temp 50°C
- Resistente / Resistant



ID#: 42 DRO



Dimensiones / Dimensions:

Largo/ Length : 30.0 cm / 11.81" Inch

Ancho/ Width: 14.5 cm / 5.71" Inch

Alto/ Hight: 5.5 cm / 2.17" Inch

Unida de Empaque / Packaging Unit :

Caja de 200 Unidades.

Box of 200 Units.

Caja No. /Box No.: 3

Cod. #: **6605051**

Especificaciones/ Specifications:

- Fabricado en R-PET / Made in R-PET
- Temp Max 50°C / Max Temp 50°C
- Resistente / Resistant



ID#: 48 DRO

**Dimensiones / Dimensions:**

Largo/ Length : 17.7 cm / 6.67 Inch

Ancho/ Width: 18.0 cm / 7.09 Inch

Alto/ Hight: 12.0 cm / 7.72 Inch

Unida de Empaque / Packaging Unit :

Caja de 220 Unidades.

Box of 220 Units.

Caja No. /Box No.: 1

Cod. #: **6605056**

Especificaciones/ Specifications:

- Fabricado en R-PET / Made in R-PET
- Temp Max 50°C / Max Temp 50°C
- Resistente / Resistant



ID#: 50 DRO

**Dimensiones / Dimensions:**

Largo/ Length : 17.8 cm / 7 Inch
Ancho/ Width: 20.6 cm / 8.11 Inch
Alto/ Hight: 7.0 cm / 2.76

Unida de Empaque / Packaging Unit :

Caja de 120 Unidades.
Box of 120 Units.
Caja No. /Box No.: 3
Cod. #: **6605063**

Especificaciones/ Specifications:

- Fabricado en R-PET / Made in R-PET
- Temp Max 50°C / Max Temp 50°C
- Resistente / Resistant



ID#:51 DRO



Dimensiones / Dimensions:

Largo/ Length : 19.5 cm / 7.68 Inch

Ancho/ Width: 22.5 cm / 8.86 Inch

Alto/ High: 6.5 cm / 2.55 Inch

Distance: 7.7 cm / 3.03

Unida de Empaque / Packaging Unit :

Caja de 120 Unidades.

Box of 120 Units.

Caja No. /Box No.: 3

Cod. #: **6605039**

Especificaciones/ Specifications:

- Fabricado en R-PET / Made in R-PET
- Temp Max 50°C / Max Temp 50°C
- Resistente / Resistant





ID#: 67 AL

NEW



Dimensiones / Dimensions:

Largo/ Length : 24.5 cm / 9.65 Inch

Ancho/ Width: 16 cm / 6.30 Inch

Alto/ Hight: 10 cm / 3.94 Inch

Unida de Empaque / Packaging Unit :

Caja de 150 Unidades.

Box of 150 Units.

Caja No. /Box No: 6

Cod. #: **6605069**

Especificaciones/ Specifications:

- Fabricado en R-PET / Made in R-PET
- Temp Max 50°C / Max Temp 50°C
- Resistente / Resistant

ECO
FRIENDLY
100%

ID#: 64 AL

**Dimensiones / Dimensions:**

Largo/ Length : 22.5 cm / 8.86 Inch
Ancho/ Width: 15.5 cm / 6.10 Inch
Alto/ Hight: 9.0 cm / 3.54 Inch

Unida de Empaque / Packaging Unit :

Caja de 200 Unidades.
Box of 200 Units.
Caja No. /Box No.: 6
Cod. #: **6605028**

Especificaciones/ Specifications:

- Fabricado en R-PET / Made in R-PET
- Temp Max 50°C / Max Temp 50°C
- Resistente / Resistant



ID#: 65 AL



Dimensiones / Dimensions:

Largo/ Length : 22.5 cm / 8.86 Inch
Ancho/ Width: 15.5 cm / 6.10 Inch
Alto/ Hight: 7.5 cm / 2.95 Inch

Unida de Empaque / Packaging Unit :

Caja de 200 Unidades.
Box of 200 Units.
Caja No. /Box No.: 6
Cod. #: **6605029**

Especificaciones/ Specifications:

- Fabricado en R-PET / Made in R-PET
- Temp Max 50°C / Max Temp 50°C
- Resistente / Resistant



ID#:65 – 3D



Dimensiones / Dimensions:

Largo/ Length : 22.9 cm / 9.02 Inch

Ancho/ Width: 15.5 cm / 6.10 Inch

Alto/ Hight: 4.5 cm / 1.77 Inch

Unida de Empaque / Packaging Unit :

Caja de 200 Unidades.

Box of 200 Units.

Caja No. /Box No.: 6

Cod. #: **6605067**

Especificaciones/ Specifications:

- Fabricado en R-PET / Made in R-PET
- Temp Max 50°C / Max Temp 50°C
- Resistente / Resistant



ID#: 63 - 12 Mini Muffin

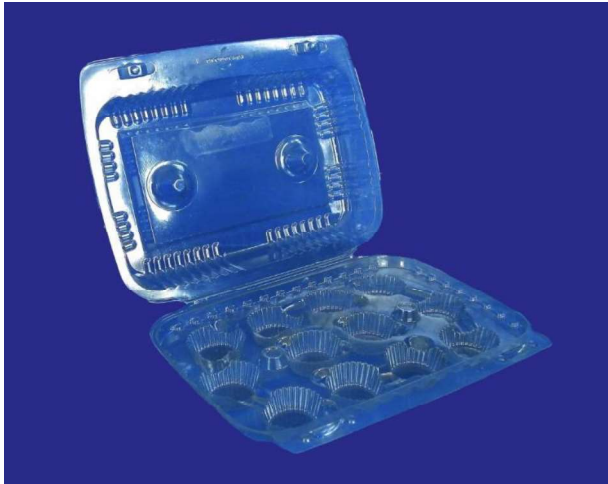

Dimensiones / Dimensions:

Largo/ Length : 22.9 cm / 9.01 Inch

Ancho/ Width: 15.5 cm / 6.10 Inch

Alto/ Hight: 4.5 cm / 1.77 Inch

Distance: 4 cm

Unida de Empaque / Packaging Unit :

Caja de 200 Unidades.

Box of 200 Units.

Caja No. /Box No.: 6

Cod. #: **6605062**

Especificaciones/ Specifications:

■Fabricado en R-PET / Made in R-PET

■Temp Max 50°C / Max Temp 50°C

■Resistente / Resistant



ID#: 64 - 6M



Dimensiones / Dimensions:

Largo/ Length : 22.8 cm / 8.98 inch

Ancho/ Width: 15.6 cm / 6.14 Inch

Alto/ High: 6.8 cm / 2.68 Inch

Distance: 6.5 cm / 2.56 Inch

Unida de Empaque / Packaging Unit :

Caja de 200 Unidades.

Box of 200 Units.

Caja No. /Box No.: 6

Cod. #: **6605077**

Especificaciones/ Specifications:

- Fabricado en R-PET / Made in R-PET
- Temp Max 50°C / Max Temp 50°C
- Resistente / Resistant



ID#:66 DRC DONAS



Dimensiones / Dimensions:

Largo/ Length : 20.5 cm / 8.07 Inch

Ancho/ Width: 15.5 cm / 6.10 Inch

Alto/ Hight: 10.2cm / 4.02 Inch

Unida de Empaque / Packaging Unit :

Caja de 150 Unidades.

Box of 150 Units.

Caja No. /Box No.: 6

Cod. #: **6605070**

Especificaciones/ Specifications:

- Fabricado en R-PET / Made in R-PET
- Temp Max 50°C / Max Temp 50°C
- Resistente / Resistant



ID#:68 – 6D



Dimensiones / Dimensions:

Largo/ Length : 22.5 cm / 8.86 Inch

Ancho/ Width: 15.5 cm / 6.10 Inch

Alto/ Hight: 7.5 cm / 2.95 Inch

Unida de Empaque / Packaging Unit :

Caja de 200 Unidades.

Box of 200 Units.

Caja No. /Box No.: 3

Cod. #: **6605072**

Especificaciones/ Specifications:

- Fabricado en R-PET / Made in R-PET
- Temp Max 50°C / Max Temp 50°C
- Resistente / Resistant



ID#:69 – 3D



Dimensiones / Dimensions:

Largo/ Length : 22.5 cm / 8.86 Inch

Ancho/ Width: 15.5 cm / 6.10 Inch

Alto/ Hight: 7.5 cm / 2.95 Inch

Unida de Empaque / Packaging Unit :

Caja de 200 Unidades.

Box of 200 Units.

Caja No. /Box No.: 3

Cod. #: **6605066**

Especificaciones/ Specifications:

- Fabricado en R-PET / Made in R-PET
- Temp Max 50°C / Max Temp 50°C
- Resistente / Resistant



ID#:30 DCR AL

**Dimensiones / Dimensions:**

Largo/ Length : 19.5 cm / 7.68 Inch
Ancho/ Width: 10.5 cm / 4.13 Inch
Alto/ Hight: 8.7 cm / 3.43 Inch

Unida de Empaque / Packaging Unit :

Caja de 270 Unidades.
Box of 270 Units.
Caja No. /Box No. : 6
Cod. #: **6605027**

Especificaciones/ Specifications:

- Fabricado en R-PET / Made in R-PET
- Temp Max 50°C / Max Temp 50°C
- Resistente / Resistant



ID#:30 DCR 1 FLAT



Dimensiones / Dimensions:

Largo/ Length : 19.5 cm / 7.68 Inch

Ancho/ Width: 10.5 cm / 4.13 Inch

Alto/ Hight: 4 cm / 1.57 Inch

Unida de Empaque / Packaging Unit :

Caja de 250 Unidades.

Box of 250 Units.

Caja No. /Box No. : 6

Cod. #: **6605034**

Especificaciones/ Specifications:

- Fabricado en R-PET / Made in R-PET
- Temp Max 50°C / Max Temp 50°C
- Resistente / Resistant



ID#:30 DCR 2 FLAT



Dimensiones / Dimensions:

Largo/ Length : 19.1 cm / 7.52" Inch

Ancho/ Width: 10.0 cm / 3.94" Inch

Alto/ Hight: 2.0 cm / 0.79" Inch

Unida de Empaque / Packaging Unit :

Caja de 400 Unidades.

Box of 400 Units.

Caja No. /Box No.: 6

Cod. #: **6605036**

Especificaciones/ Specifications:

- Fabricado en R-PET / Made in R-PET
- Temp Max 50°C / Max Temp 50°C
- Resistente / Resistant



ID#:70 DRC 6MG

**Dimensiones / Dimensions:**

Largo/ Length : 30.5 cm / 12 Inch
Ancho/ Width: 23.0 cm / 9.06 Inch
Alto/ Hight: 10.0 cm / 3.94 Inch

Unida de Empaque / Packaging Unit :

Caja de 80 Unidades.
Box of 80 Units.
Caja No. /Box No.: 3
Cod. #: **6605198**

Especificaciones/ Specifications:

- Fabricado en R-PET / Made in R-PET
- Temp Max 50°C / Max Temp 50°C
- Resistente / Resistant



ID#:70 DRC LISO



Dimensiones / Dimensions:

Largo/ Length : 30.5 cm / 12.0" Pulg.

Ancho/ Width: 23.0 / 9.05" Pulg.

Alto/ Hight: 10.0 cm / 4" Pulg.

Unida de Empaque / Packaging Unit :

Caja de 80 Unidades.

Box of 80 Unids.

Caja No. /Box No. 3

Cod. #: **6605197**

Especificaciones/ Specifications:

- Fabricado en R-PET / Made in R-PET
- Temp Max 50°C / Max Temp 50°C
- Resistente / Resistant



ID#:71 DRC 12M



Dimensiones / Dimensions:

Largo/ Length : 30.5 cm / 12 " Inch

Ancho/ Width: 23.0 cm / 9" Inch

Alto/ High: 10.0 cm / 4" Inch

Distance: 6 cm

Unida de Empaque / Packaging Unit :

Caja de 80 Unidades.

Box of 80 Units.

Caja No. /Box No.: 3

Cod. #: **6605199**

Especificaciones/ Specifications:

- Fabricado en R-PET / Made in R-PET
- Temp Max 50°C / Max Temp 50°C
- Resistente / Resistant



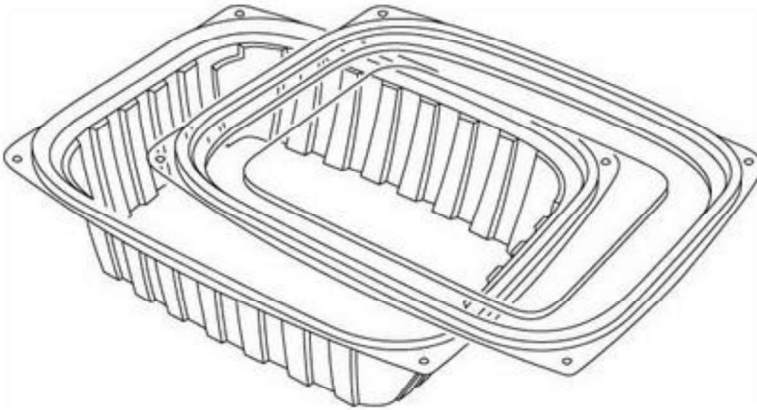

eco

CATALOGO:CONTENEDORES DELI



ID#: 8 DRC

**Dimensiones / Dimensions:**

Largo/ Length : 13.5 cm / 5.31" Inch
Ancho/ Width: 11.5 cm / 4.53" Inch
Alto/ Hight: 4.0 cm / 1.57 " Inch

Unida de Empaque / Packaging Unit :

Caja de 240 Unidades.
Box of 240 Units.
Caja No. /Box No.: 6
Cod. #: **6605190**

Especificaciones/ Specifications:

- Fabricado en R-PET / Made in R-PET
- Temp Max 50°C / Max Temp 50°C
- Resistente / Resistant



ID#: 16 DRC



Dimensiones / Dimensions:

Largo/ Length : 13.5 cm

Ancho/ Width: 11.5 cm

Alto/ Hight: 5.0 cm

Unida de Empaque / Packaging Unit :

Caja de 240 Unidades.

Box of 240 Units.

Caja No. /Box No. 6

Cod. #: **6605191**

Especificaciones/ Specifications:

- Fabricado en R-PET / Made in R-PET
- Temp Max 50°C / Max Temp 50°C
- Resistente / Resistant



ID#: 32 DRC



Dimensiones / Dimensions:

Largo/ Length : 17.5 cm

Ancho/ Width: 15.0 cm

Alto/ Hight: 6.0 cm

Unida de Empaque / Packaging Unit :

Caja de 150 Unidades.

Box of 150 Units.

Caja No. /Box No.: 6

Cod. #: **6605200**

Especificaciones/ Specifications:

- Fabricado en R-PET / Made in R-PET
- Temp Max 50°C / Max Temp 50°C
- Resistente / Resistant



ID#: 33 DRC

**Dimensiones / Dimensions:**

Largo/ Length : 17.5 cm

Ancho/ Width: 15.0 cm

Alto/ Hight: 5.0 cm

Unida de Empaque / Packaging Unit :

Caja de 150 Unidades.

Box of 150 Units.

Caja No. /Box No.: 6

Cod. #: **6605203**

Especificaciones/ Specifications:

- Fabricado en R-PET / Made in R-PET
- Temp Max 50°C / Max Temp 50°C
- Resistente / Resistant



ID#: 7DR 5D



Dimensiones / Dimensions:

Tapa/Cap : 23.0 cm

Base/Base: 6.0 cm

Unida de Empaque / Packaging Unit :

Caja de 90 Unidades.

Box of 90 Units

Caja No. /Box No.: 1

Cod. #: **6605121**

Especificaciones/ Specifications:

- Fabricado en R-PET / Made in R-PET
- Temp Max 50°C / Max Temp 50°C
- Resistente / Resistant



ID#: 12C



Dimensiones / Dimensions:

Largo/ Length : 19.0 cm
Ancho/ Width: 19.0 cm
Alto/ Hight: 5.5 cm

Unida de Empaque / Packaging Unit :

Caja de 100 Unidades.
Box of 100 Units.
Caja No. /Box No. : 6
Cod. #: **6605142**

Especificaciones/ Specifications:

- Fabricado en R-PET / Made in R-PET
- Temp Max 50°C / Max Temp 50°C
- Resistente / Resistant

NEW

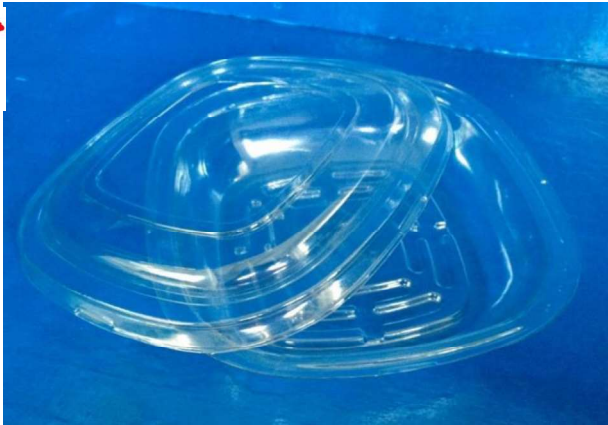

ECO
FRIENDLY
100%

ID#: 7-250



Dimensiones / Dimensions:

Ancho/ Width: 17.2 cm

Alto/ Hight: 10.2 cm

Unida de Empaque / Packaging Unit :

Caja de 160 Unidades.

Box of 160 Units.

Caja No. /Box No. 6

Cod. #: **6605155**

Especificaciones/ Specifications:

- Fabricado en R-PET / Made in R-PET
- Temp Max 50°C / Max Temp 50°C
- Resistente / Resistant



ID#: 7-325 DR



Dimensiones / Dimensions:

Ancho/ Width: 17.2 cm

Alto/ Hight: 10.2 cm

Unida de Empaque / Packaging Unit :

Caja de 120 Unidades.

Box of 120 Units.

Caja No. /Box No. 6

Cod. #: **6605156**

Especificaciones/ Specifications:

- Fabricado en R-PET / Made in R-PET
- Temp Max 50°C / Max Temp 50°C
- Resistente / Resistant



ID#: Bandeja 210



Dimensiones / Dimensions:

Largo/ Length : 16.4 cm

Ancho/ Width: 11.4 cm

Alto/ Hight: 2.5 cm

Unida de Empaque / Packaging Unit :

Caja de 800 Unidades.

Box of 800 Units.

Caja No. /Box No.: 6

Cod. #: **6605705**

Especificaciones/ Specifications:

- Fabricado en R-PET / Made in R-PET
- Temp Max 50°C / Max Temp 50°C
- Resistente / Resistant



ID#: Bandeja 214



Dimensiones / Dimensions:

Largo/ Length : 19.9 cm / 7 ¾ "

Ancho/ Width: 14.0 cm / 5 ½ "

Alto/ Hight: 2.0 cm / 1"

Unida de Empaque / Packaging Unit :

Caja de 1000 Unidades.

Box of 1000 Units.

Caja No. /Box No.: 6

Cod. #: **6605701**

Especificaciones/ Specifications:

- Fabricado en R-PET / Made in R-PET
- Temp Max 50°C / Max Temp 50°C
- Resistente / Resistant



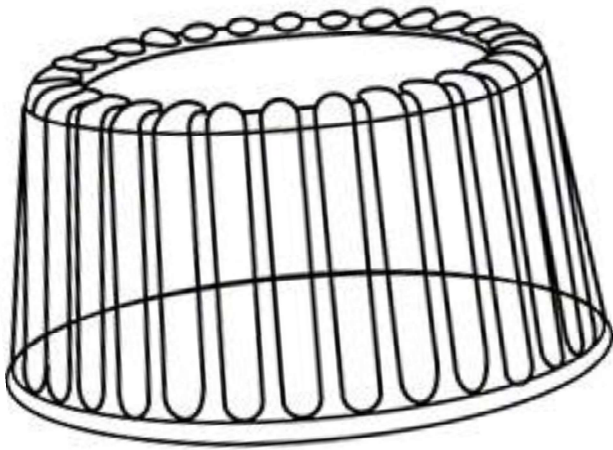

eco

CATALOGO: DOMOS PASTELEROS





GLOBALPAK **eco**

Style.
CLASSICO

ID#: 6 DR



Dimensiones / Dimensions:

Base/Base : 19.5 cm
Domo/Dome: 8.0 cm

Unida de Empaque / Packaging Unit :

Caja de 50 Unidades.
Box of 50 Units
Caja No. /Box No. : 6
Cod. #: **6605123**

Especificaciones/ Specifications:

- Fabricado en R-PET / Made in R-PET
- Temp Max 50°C / Max Temp 50°C
- Resistente / Resistant



ID#: 8 DR



Dimensiones / Dimensions:

Base/Base : 23.0 cm
Domo/Dome: 8.0 cm

Unidad de Empaque / Packaging Unit :

Caja de 100 Unidades.
Box of 100 Units
Caja No. /Box No.: 1
Cod. #: **6605113**

Especificaciones/ Specifications:

- Fabricado en R-PET / Made in R-PET
- Temp Max 50°C / Max Temp 50°C
- Resistente / Resistant



ID#: 12 DR Bajo



Dimensiones / Dimensions:

Base/Base : 26.5 cm
Domo/Dome: 8.0 cm

Unida de Empaque / Packaging Unit :

Caja de 40 Unidades.
Box of 40 Units
Caja No. /Box No.: 3
Cod. #: **6605223**

Especificaciones/ Specifications:

- Fabricado en R-PET / Made in PET
- Temp Max 50°C / Max Temp 50°C
- Resistente / Resistant



ID#: 12DR Alto



Dimensiones / Dimensions:

Base/Base : 26.5 cm
Domo/Dome: 12.0 cm

Unida de Empaque / Packaging Unit :

Caja de 40 Unidades.
Box of 40 Units
Caja No. /Box No.: 3
Cod. #: **6605099**

Especificaciones/ Specifications:

- Fabricado en R-PET / Made in R-PET
- Temp Max 50°C / Max Temp 50°C
- Resistente / Resistant



ID#: 14 DR



Dimensiones / Dimensions:

Base/Base : 30.5 cm
Domo/Dome: 12.0 cm

Unidad de Empaque / Packaging Unit :

Caja de 40 Unidades.
Box of 40 Units
Caja No. /Box No.: 1
Cod. #: **6605229**

Especificaciones/ Specifications:

- Fabricado en R-PET / Made in R-PET
- Temp Max 50°C / Max Temp 50°C
- Resistente / Resistant

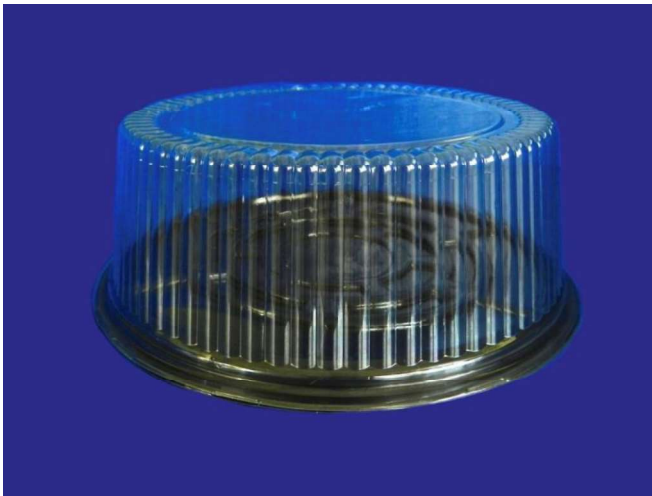

ID#: 16 DR



Dimensiones / Dimensions:

Base/Base : 33.5 cm
Domo/Dome: 11.0 cm

Unidad de Empaque / Packaging Unit :

Caja de 40 Unidades.
Box of 40 Units
Caja No. /Box No. 3
Cod. #: **6605157**

Especificaciones/ Specifications:

- Fabricado en R-PET / Made in R-PET
- Temp Max 50°C / Max Temp 50°C
- Resistente / Resistant



ID#: 9 DR

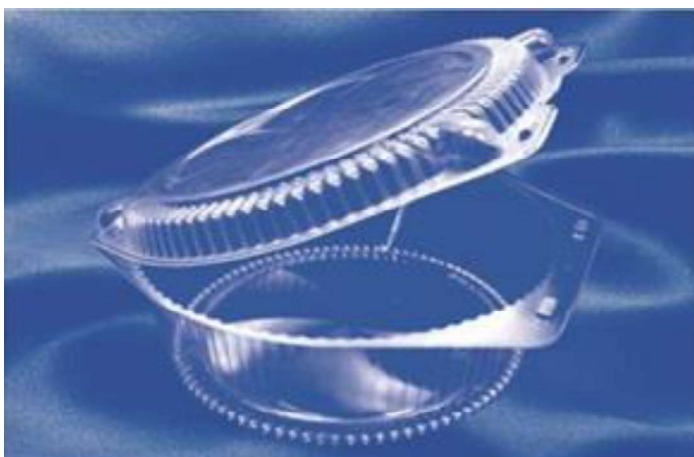

Dimensiones / Dimensions:

Base/Base : 24.0 cm
Domo/Dome: 9.4 cm

Unidad de Empaque / Packaging Unit :

Caja de 150 Unidades.
Box of 150 Units
Caja No. /Box No. : 1
Cod. #: **6605165**

Especificaciones/ Specifications:

- Fabricado en R-PET / Made in R-PET
- Temp Max 50°C / Max Temp 50°C
- Resistente / Resistant





GLOBALPAK **eco**

Style.
PETALOS

ID#: 7-325 MINI



Dimensiones / Dimensions:

Ancho/ Width: 17.2 cm

Alto/ Hight: 10.2 cm

Unida de Empaque / Packaging Unit :

Caja de 120 Unidades.

Box of 120 Units.

Caja No. /Box No. 6

Cod. #: **6605164**

Especificaciones/ Specifications:

- Fabricado en R-PET / Made in R-PET
- Temp Max 50°C / Max Temp 50°C
- Resistente / Resistant



ID#: 7 DR



Dimensiones / Dimensions:

Base/Base : 23.0 cm

Domo/Dome: 6.0 cm

Unida de Empaque / Packaging Unit :

Caja de 120 Unidades.

Box of 120 Units

Caja No. /Box No.: 1

Cod. #: **6605117**

Especificaciones/ Specifications:

- Fabricado en R-PET / Made in R-PET
- Temp Max 50°C / Max Temp 50°C
- Resistente / Resistant



ID#: 501 PD



Dimensiones / Dimensions:

Base/Base : 23.0 cm
Domo/Dome: 8.0 cm

Unidad de Empaque / Packaging Unit :

Caja de 100 Unidades.
Box of 100 Units
Caja No. /Box No.: 1
Cod. #: **6605187**

Especificaciones/ Specifications:

- Fabricado en R-PET / Made in R-PET
- Temp Max 50°C / Max Temp 50°C
- Resistente / Resistant



ID#: 500 PD



Dimensiones / Dimensions:

Base/Base : 23.0 cm
Domo/Dome: 10.0 cm

Unida de Empaque / Packaging Unit :

Caja de 90 Unidades.
Box of 90 Units
Caja No. /Box No.: 1
Cod. #: **6605008**

Especificaciones/ Specifications:

- Fabricado en R-PET / Made in R-PET
- Temp Max 50°C / Max Temp 50°C
- Resistente / Resistant



ID#: 512 PD



Dimensiones / Dimensions:

Base/Base : 26.5 cm
Domo/Dome: 11.5 cm

Unidad de Empaque / Packaging Unit :

Caja de 40 Unidades.
Box of 40 Units
Caja No. /Box No.: 3
Cod. #: **6605108**

Especificaciones/ Specifications:

- Fabricado en R-PET / Made in R-PET
- Temp Max 50°C / Max Temp 50°C
- Resistente / Resistant

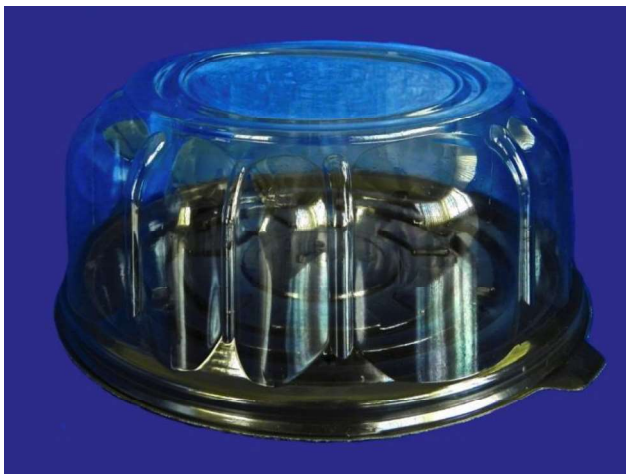

ID#: 56 PD



Dimensiones / Dimensions:

Base/Base : 48.0 cm x 35.0 cm
Domo/Dome: 12.0 cm

Unidad de Empaque / Packaging Unit :

Caja de 25 Unidades.
Box of 25 Units
Caja No. /Box No.: 1
Cod. #: **6605158**

Especificaciones/ Specifications:

- Fabricado en R-PET / Made in R-PET
- Temp Max 50°C / Max Temp 50°C
- Resistente / Resistant





GLOBALPAK **eco**

Style.
ROMANESCO

ID#: 8.5 BAJO



Dimensiones / Dimensions:

Base/Base : 23.0 cm
Domo/Dome: 8.0 cm

Unidad de Empaque / Packaging Unit :

Caja de 100 Unidades.
Box of 100 Units
Caja No. /Box No.: 1
Cod. #: **6605248**

Especificaciones/ Specifications:

- Fabricado en R-PET / Made in R-PET
- Temp Max 50°C / Max Temp 50°C
- Resistente / Resistant

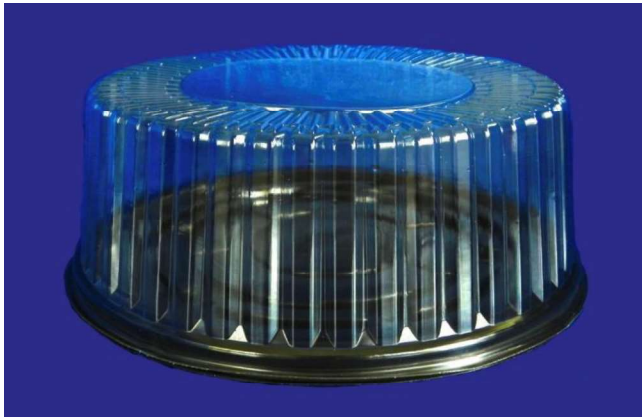

ID#: 8.5 ALTO



Dimensiones / Dimensions:

Base/Base : 23.0 cm
Domo/Dome: 10.5 cm

Unidad de Empaque / Packaging Unit :

Caja de 80 Unidades.
Box of 80 Units
Caja No. /Box No.: 1
Cod. #: **6605100**

Especificaciones/ Specifications:

- Fabricado en R-PET / Made in R-PET
- Temp Max 50°C / Max Temp 50°C
- Resistente / Resistant



ID#: 13 DR

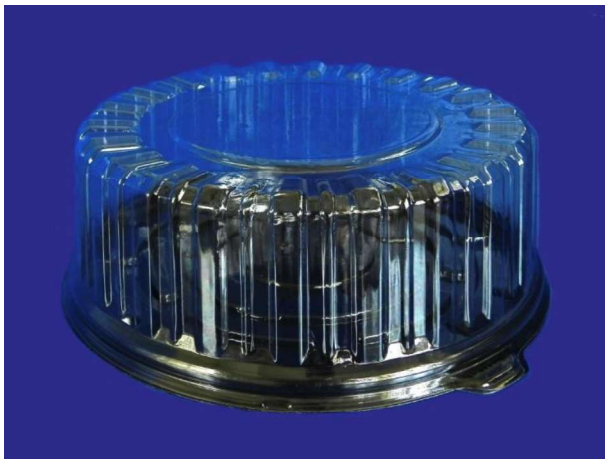

Dimensiones / Dimensions:

Base/Base : 26.5 cm
Domo/Dome: 12.0 cm

Unida de Empaque / Packaging Unit :

Caja de 40 Unidades.
Box of 40 Units
Caja No. /Box No.: 3
Cod. #: **6605097**

Especificaciones/ Specifications:

- Fabricado en R-PET / Made in R-PET
- Temp Max 50°C / Max Temp 50°C
- Resistente / Resistant



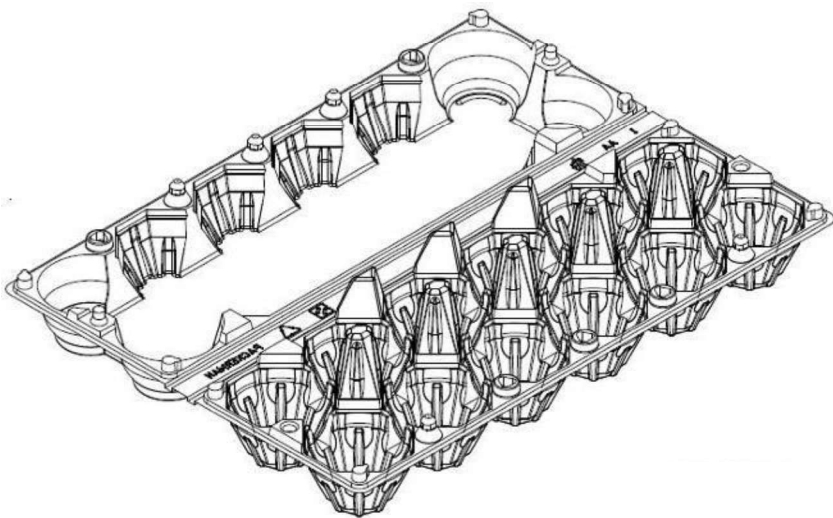

CATALOGO: BANDEJA HUEVOS





ID#: 12H



Dimensiones / Dimensions:

Largo/ Length : 28.4 cm

Ancho/ Width: 9.5 cm

Alto/ Hight: 6.6 cm

Unida de Empaque / Packaging Unit :

Fardo de 150 Unidades.

Box of 150 Units.

Caja No. /Box No. : Bolsa / Bag

Cod. #: **6605081**

Especificaciones/ Specifications:

- Fabricado en R-PET / Made in R-PET
- Temp Max 50°C / Max Temp 50°C
- Resistente / Resistant





ID#: 30H



Dimensiones / Dimensions:

Largo/ Length : 28.5 cm

Ancho/ Width: 24.0 cm

Alto/ Hight: 7.0 cm

Unida de Empaque / Packaging Unit :

Fardo de 100 Unidades.

Box of 100 Units.

Caja No. /Box No.: Bolsa/Bag: 3

Cod. #: **6605086**

Especificaciones/ Specifications:

- Fabricado en R-PET / Made in R-PET
- Temp Max 50°C / Max Temp 50°C
- Resistente / Resistant





CATALOGO:  **TERRA PACK**
BIOBASADO

eco 





MATERIA PRIMA: (Fécula Maíz)

- ▶ Hacemos de su conocimiento que nuestra materia prima para nuestro contenedores multiusos, platos, vasos, cubierto y set de vajillas desechables son elaborados con material CPLA y FECULA DE MAIZ NO PROCESADA.

COMPUESTO QUIMICOS: Acido Poli láctico Cristalizado (CPLA) + FECULA DE MAIZ

- ▶ Al hacer este compuesto, nuestros productos son 100% biodegradables, los productos biodegradables están diseñados para que por acción de organismos vivos, lo utilicen como fuente de carbono y por lo tanto consumiendo el material plástico, en nuestro caso CPLA.
- ▶ Nuestros productos son fabricados con materias primas orgánicas que proceden de fuentes renovables, como lo es la fécula de Maíz.
- ▶ Con la tecnología enzimática anaerobia, que permiten que plástico (CPLA) o biobasado, cuando termina su vida útil, sea desechado en un tiradero de basura o relleno sanitario, y por acción de microorganismos anaerobios presentes naturalmente en estos sitios, comenzará la biodegradación acelerada de estos materiales plásticos. Estos aditivos tienen la ventaja de permitir que el plástico se recicle, ya que no afectan sus propiedades originales.
- ▶ El Tiempo aproximado para su degradación en un ambiente natural es 24 meses. Para el resultado final de la degradación deberá estar expuesto a H₂O (agua /humedad) CO₂ (Dióxido de Carbono), O (oxígeno) y temperatura solar.



ID#: Plato No.6 Terrapack

NEW



Dimensiones / Dimensions:

✓ Plato No. 6

Unidad de Empaque / Packaging Unit :

Fardo de 100 Unidades / 20und

Box of 100 Units / 20 units

Total : 2000unds / 2000 units

Caja No. /Box No.: Bolsa/Bag: 6B

Cod. #:

Especificaciones/ Specifications:

- Fabricado en Fécula Maíz / Made with Cornstarch.
- Temp Max 50°C / Max Temp 50°C
- Resistente / Resistant

ECO
FRIENDLY
100%

ID#: Plato No.9

Terrapack

NEW



Dimensiones / Dimensions:

✓ Plato No. 9

Unidad de Empaque / Packaging Unit :

Fardo de 50 Unidades / 20und

Box of 50 Units / 20 units

Total : 1000unds / 1000 units

Caja No. /Box No.: Bolsa/Bag: 6B

Cod. #:

Especificaciones/ Specifications:

- Fabricado en Fécula Maíz / Made with Cornstarch.
- Temp Max 50°C / Max Temp 50°C
- Resistente / Resistant



ID#: Plato No.6 ECO Terrapack

NEW



ECO
FRIENDLY
100%



Dimensiones / Dimensions:

✓ Plato No. 6ECO

Unidad de Empaque / Packaging Unit :

Fardo de 36 Unidades / 20und

Box of 36 Units / 20 units

Total : 720unds / 720 units

Caja No. /Box No.: Bolsa/Bag: 6B

Cod. #:

Especificaciones/ Specifications:

- Fabricado en Fécula Maíz / Made with Cornstarch.
- Temp Max 50°C / Max Temp 50°C
- Resistente / Resistant

ID#: Plato No.9 ECO Terrapack

NEW



Dimensiones / Dimensions:

✓ Plato No. 9ECO

Unidad de Empaque / Packaging Unit :

Fardo de 24 Unidades / 20und

Box of 24 Units / 20 units

Total : 480unds / 480 units

Caja No. /Box No.: Bolsa/Bag: 6B

Cod. #:

Especificaciones/ Specifications:

- Fabricado en Fécula Maíz / Made with Cornstarch.
- Temp Max 50°C / Max Temp 50°C
- Resistente / Resistant

ECO
FRIENDLY
100%

ID#: BANDEJA 214

Terrapack

NEW



Dimensiones / Dimensions:

- ✓ BANDEJA 214 TERRAPACK
- ✓ Medida/ Size: 4" X 8"

Unida de Empaque / Packaging Unit :

Fardo de 50 Unidades / 20und
Box of 50 Units / 20 units
Total : 1000unds / 1000 units
Caja No. /Box No.: Bolsa/Bag: 6B
Cod. #:

Especificaciones/ Specifications:

- Fabricado en Fécula Maíz / Made with Cornstarch.
- Temp Max 50°C / Max Temp 50°C
- Resistente / Resistant

ECO
FRIENDLY
100%

ID#: BANDEJA 200

Terrapack

NEW



ECO FRIENDLY
100%

GLOBALPAK

Dimensiones / Dimensions:

- ✓ BANDEJA 200 TERRAPACK
- ✓ Medida/ Size: 5" X 5"

Unida de Empaque / Packaging Unit :

Fardo de 50 Unidades / 20und
Box of 50 Units / 20 units
Total : 400unds / 400 units
Caja No. /Box No.: Bolsa/Bag: 6B
Cod. #:

Especificaciones/ Specifications:

- Fabricado en Fécula Maíz / Made with Cornstarch.
- Temp Max 50°C / Max Temp 50°C
- Resistente / Resistant

ID#: BANDEJA 6820

Terrapack

NEW



ECO
FRIENDLY
100%



GLOBALPAK

Dimensiones / Dimensions:

- ✓ BANDEJA 6820 TERRAPACK
- ✓ Medida/ Size: 8" X 8"

Unida de Empaque / Packaging Unit :

Fardo de 8 Unidades / 20und
Box of 8 Units / 20 units
Total : 160unds / 160 units
Caja No. /Box No.: Bolsa/Bag: 6B
Cod. #:

Especificaciones/ Specifications:

- Fabricado en Fécula Maíz / Made with Cornstarch.
- Temp Max 50°C / Max Temp 50°C
- Resistente / Resistant

ID#: BANDEJA 32DRC

Terrapack

NEW



Dimensiones / Dimensions:

- ✓ BANDEJA 6820 TERRAPACK
- ✓ Medida/ Size: 8" X 8"

Unida de Empaque / Packaging Unit :

Fardo de 8 Unidades / 20und
Box of 8 Units / 20 units
Total : 160unds / 160 units
Caja No. /Box No.: Bolsa/Bag: 6B
Cod. #:

Especificaciones/ Specifications:

- Fabricado en Fécula Maíz / Made with Cornstarch.
- Temp Max 50°C / Max Temp 50°C
- Resistente / Resistant



ID#: BANDEJA 7-250

Terrapack



NEW

ECO
FRIENDLY
100%



Dimensiones / Dimensions:

- ✓ BANDEJA 7-250 TERRAPACK
- ✓ Medida/ Size: 7"

Unida de Empaque / Packaging Unit :

Fardo de 6Unidades / 20und
Box of 6Units / 20 units
Total : 120unds / 120 units
Caja No. /Box No.: Bolsa/Bag: 6B
Cod. #:

Especificaciones/ Specifications:

- Fabricado en Fécula Maíz / Made with Cornstarch.
- Temp Max 50°C / Max Temp 50°C
- Resistente / Resistant



eco

CATALOGO: DESECHABLES





Style.

PIÑATA FACTORY

ID#: Plato No.6



Dimensiones / Dimensions:

✓ Plato/ Plate No. 6"

Unida de Empaque / Packaging Unit :

Fardo de 40 Unidades / 25und

Box of 40 Units / 25 units

Total : 1000unds / 1000 units

Caja No. /Box No.: Bolsa/Bag: 6B

COLOR: Azul, Celeste, Amarillo, Rosado, Transparente, Rojo Verde, Lila

Especificaciones/ Specifications:

- Fabricado en Fécula Maíz / Made with Cornstarch.
- Temp Max 50°C / Max Temp 50°C
- Resistente / Resistant



ID#: Plato No.9



Dimensiones / Dimensions:

✓ Plato/ Plate No. 9"

Unida de Empaque / Packaging Unit :

Fardo de 40 Unidades / 25und

Box of 40 Units / 25 units

Total : 1000unds / 1000 units

Caja No. /Box No.: Bolsa/Bag: 6B

COLORS: Azul, Celeste, Amarillo, Rosado, Transparente, Rojo Verde, Lila

Especificaciones/ Specifications:

- Fabricado en Fécula Maíz / Made with Cornstarch.
- Temp Max 50°C / Max Temp 50°C
- Resistente / Resistant





Style.

ECO-Flexipak

ID#:Plato ECO No.6



Dimensiones / Dimensions:

✓ Plato/ Plate ECO No. 6"

Unida de Empaque / Packaging Unit :

Fardo de 24 paq/ 25und

Box of 24 paq/ 25 units

Total : 600unds / 600 units

Caja No. /Box No.: Bolsa/Bag: 6B

COLOR: Verde, Transparente, Azul, Amarillo, Rojo

Especificaciones/ Specifications:

- Fabricado en Fécula Maíz / Made with Cornstarch.
- Temp Max 50°C / Max Temp 50°C
- Resistente / Resistant



ID#: Plato ECO No.9



Dimensiones / Dimensions:

✓ Plato/ Plate ECO No. 9"

Unida de Empaque / Packaging Unit :

Fardo de 12 paqs / 25und

Box of 12 paqs / 25 units

Total : 300unds / 300 units

Caja No. /Box No.: Bolsa/Bag: 6B

COLORS: Verde, Transparente, Azul, Amarillo, Rojo

Especificaciones/ Specifications:

- Fabricado en Fécula Maíz / Made with Cornstarch.
- Temp Max 50°C / Max Temp 50°C
- Resistente / Resistant



SOLUCIONES SOSTENIBLES



SOLUCIONES
EMPAQUES
INTELIGENTES

REUSE
REDUCE
RECYCLE

